

POINT MICROMETERS

- Measure the web thickness of drills, small grooves and keyways
- Graduation 0.01mm
- Ratchet stop
- Carbide tips
- Supplied with setting standards (except 0-25mm)



3230-25A

(mm)

Code	Range	Type	Accuracy	L	b
3230-25A	0-25mm	A	4μm	57	32
3230-50A	25-50mm	A	4μm	82	44.5
3230-75A	50-75mm	A	5μm	107	57
3230-100A	75-100mm	A	5μm	132.6	69.5
3230-25BA	0-25mm	B	4μm	57	32
3230-50BA	25-50mm	B	4μm	82	44.5
3230-75BA	50-75mm	B	5μm	107	57
3230-100BA	75-100mm	B	5μm	132.6	69.5

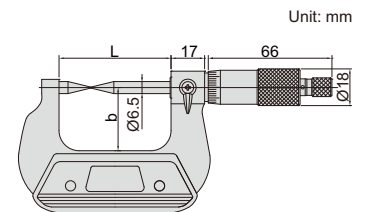
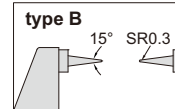
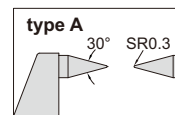

DATA
OUTPUT

IP65
WATERPROOF

DIGITAL POINT MICROMETERS

- Measure the web thickness of drills, small grooves and keyways
- Resolution 0.001mm/0.00005"
- IP65 dust/waterproof
- Button function: on/off, set, mm/inch, ABS/INC
- Data output
- Automatic power off
- Ratchet stop
- Carbide tips
- Supplied with setting standards (except 0-25mm/0-1")
- Optional accessory: data output cable (code 7315-30, 7302-30)



3530-25A

(mm)

Code	Range	Type	Accuracy	L	b
3530-25A	0-25mm/0-1"	A	±4μm	57	32
3530-50A	25-50mm/1-2"	A	±4μm	82	44.5
3530-75A	50-75mm/2-3"	A	±5μm	107	57
3530-100A	75-100mm/3-4"	A	±5μm	132.6	69.5
3530-25BA	0-25mm/0-1"	B	±4μm	57	32
3530-50BA	25-50mm/1-2"	B	±4μm	82	44.5
3530-75BA	50-75mm/2-3"	B	±5μm	107	57
3530-100BA	75-100mm/3-4"	B	±5μm	132.6	69.5

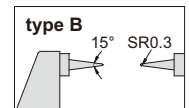
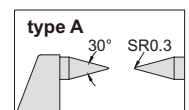
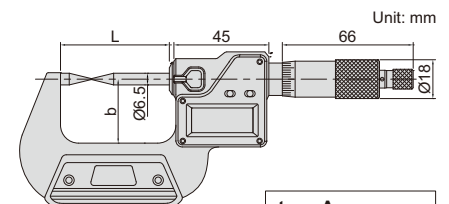

HIGH PRECISION DIGITAL POINT MICROMETERS/SNAP GAGES



ABSOLUTE ENCODER, THE ORIGINAL DATA REMAINS AFTER POWER OFF

ONE TURN OF SLEEVE MAKES 5MM SPINDLE FEED, PRESS THE FORK, THE SPINDLE RETRACTS 3MM

IP65
WATERPROOF

MEASUREMENT ACCURACY IS NOT AFFECTED BY THE USE OF SLEEVE

NON-ROTATING SPINDLE

ATTENTION: RECHARGEABLE BATTERY, FOR 24 HOURS CONTINUOUS WORKING

DATA OUTPUT

5



3354-25

- Measure the web thickness of drills, small grooves and keyways
- Absolute encoder, the original data remains after power off
- Adjustable resolution: 0.0002mm/0.00001"
0.001mm/0.00005"
0.01mm/0.0005"
- One turn of sleeve makes 5mm spindle feed
- Measurement accuracy is not affected by the use of sleeve
- Press the fork, the spindle retracts 3mm
- Linear ball bearings for ten million times use
- Carbide spindle and anvil
- Measuring force 7-10N
Customizable measuring force range 2-12N
Attention: small measuring force will reduce the dustproof and waterproof level
- Button function: data output, tolerance, data preset, data hold, measuring direction change, max./min./TIR, power off time, on/off, zero, mm/inch, adjust resolution
- Supplied with gage blocks for zero setting (except 0-25mm/0-1")
- Power: rechargeable battery, for 24 hours continuous working

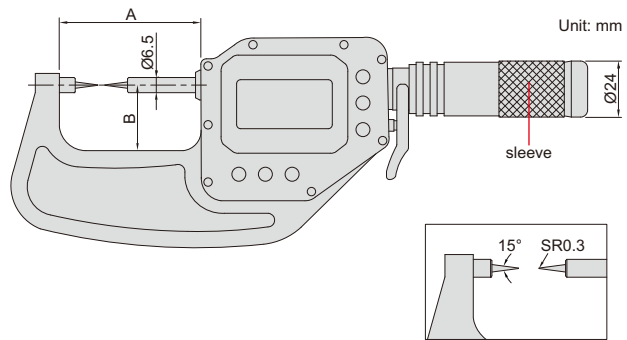

With data interface

Optional accessory:
wireless transmitter, code **7315-60**, wireless receiver, code **7315-2**, **7315-3**
data output cable (keyboard format), code **7302-60**
data output cable (serial port format), code **7305-G60**
(cable length 3m, optional cable length maximum 15m; RS232 protocol, optional RS485 protocol)

Code	Range	Accuracy	Repeatability	A	B
3354-25 *	0-25mm/0-1"	2µm	1µm	63mm	25mm
3354-50 *	25-50mm/1-2"	2µm	1µm	88mm	42mm
3354-75 *	50-75mm/2-3"	2µm	1µm	113mm	56mm

Built-in wireless

Optional accessory:
wireless receiver (keyboard format), code **2134-R1**
wireless receiver (serial port format), code **2134-R2**

Code	Range	Accuracy	Repeatability	A	B
3354-25WL *	0-25mm/0-1"	2µm	1µm	63mm	25mm
3354-50WL *	25-50mm/1-2"	2µm	1µm	88mm	42mm
3354-75WL *	50-75mm/2-3"	2µm	1µm	113mm	56mm

* Supplied with manufacturer inspection certificate

warning when over tolerance

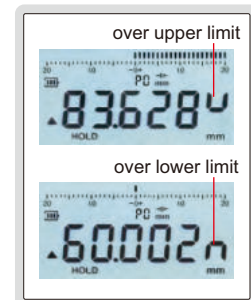

wireless receiver
2134-R1, 2134-R2 (optional)

